

Article number: 03003005

Description: Fluro Rod End GIS 5
Zinc Plated

Measures

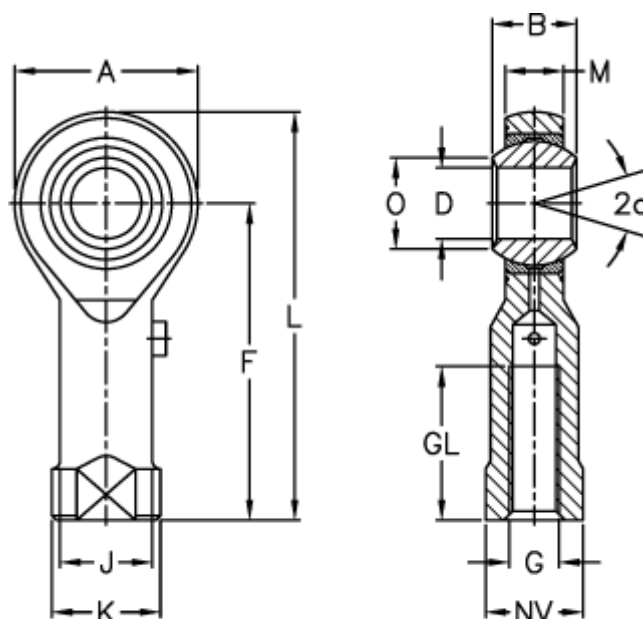

Str. 2-3 uden smørenippel

A	= 18	J	= 9	Weight (g) = 18
a (degrees)	= 13	K	= 11	
B	= 8	L	= 36	
D	= 5	M	= 6	
Dynamic load C (kN)	= 3.3	NV	= 9	
F	= 27	O	= 7.7	
G	= M5	Permissible rpm	= 1200	
GL	= 10	Static load C0 (kN)	= 8	